

DESIGN PRESERVATION MODELS



LANDMARK STRUCTURES®

HO
SELECT
BUILDING KIT



Setting Superior Standards in
Design, Detail and Assembly

- Architectural Works of Art
- Craftsmanship Detailing
- Positive Alignment System

OUR HOUSE

4 1/4 in W x 7 1/8 in D x 5 in H
(10.7 cm x 18 cm x 12.7 cm)



**Woodland
Scenics®**

PO Box 98, Linn Creek, MO 65052

#12700

DESIGN PRESERVATION MODELS



Our House

DPM Building Kit
HO Scale 1:87

This item is not a Children's Product and is not intended for use by Children.

QUALITY GUARANTEE

We guarantee the quality of all Woodland Scenics products. If this product does not perform properly, please contact us.

CAUTION

Cutting tools recommended. Use with care.

MODELING AND CARE INFORMATION

This kit suggests the use of materials that may stain or cause damage. Take care to cover project area and clothing appropriately. Follow recommendations for use and clean up.

Building Kit Contents

- First-story Walls (4 pcs)
- Second-story Wall Assembly
- Roof
- Sprues with Details
- Phillips Screws (4 pcs)
- Wire (2 sets)
- Pre-printed Window Material
- Clear Window Material
- Blackout Paper
- Screen for Door

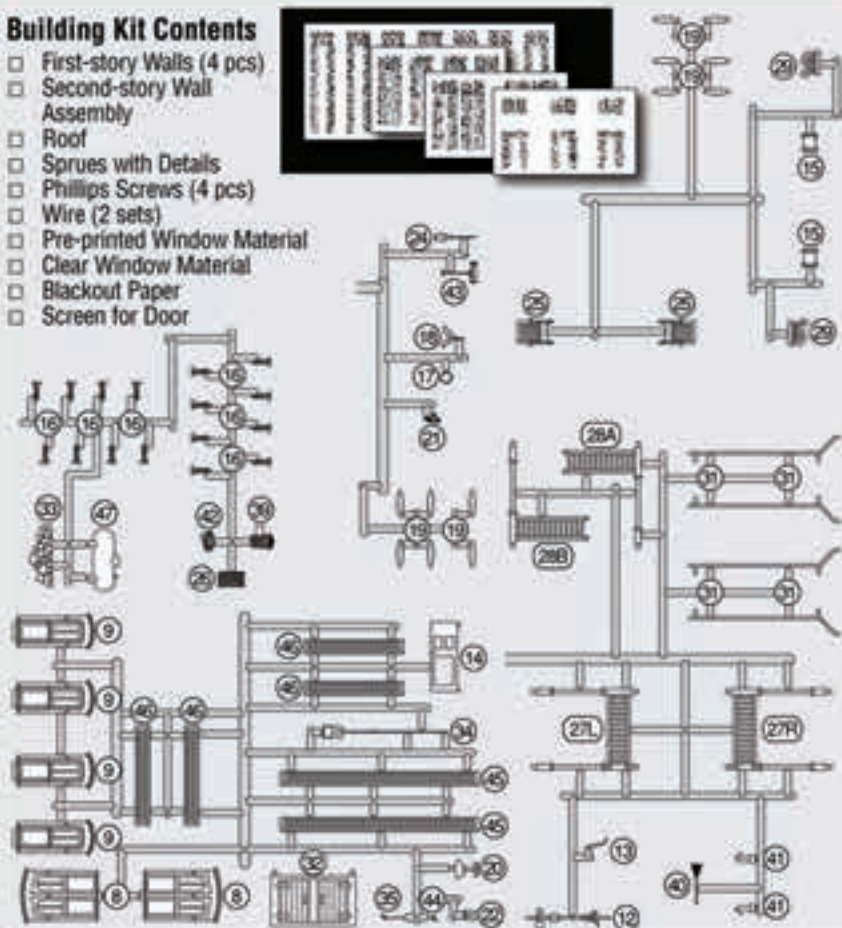

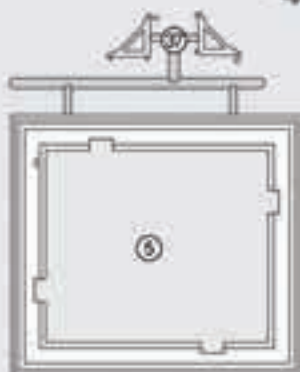
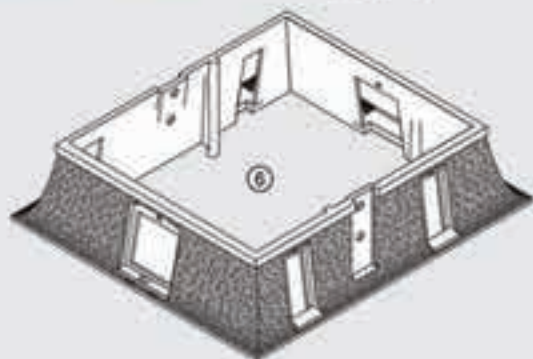

Before You Begin

- Read through instruction booklet.
- Check kit contents.
- Collect additional supplies.
- Cover project area with newspaper.

Additional Supplies

- Paints (acrylic or enamel)*
- Primer*
- Model Glue* or Cyanoacrylate Adhesive (CA glue)
- Painting Tools
- Hobby Knife
- Phillips Screwdriver
- Fine Grade Sandpaper
- Tweezers

NOTE: Always allow glue to set before moving on to the next construction step.

*Contact your local hobby shop for recommendations.

1. Building and Detail Preparation

- Remove mold flash and tabs from Building Components and Details using a hobby knife and sandpaper (Fig. 1a).
- Remove Building Components from sprues using a hobby knife (or flush cutting shears). Sand off parting lines. Do NOT remove Details from sprues at this time.
- Wash Building Components and Details in warm, soapy water. Rinse and let dry.
- Remove Details from sprues using a hobby knife (or flush cutting shears). Sand off any mold flash or parting lines. (Fig. 1b)

TIP! Leave Flowers (16) and Fern Leaves (19) attached to sprue while priming and painting (Step 2). Remove when painting is complete, then touch up cut-lines.



2. Prime and Paint

Do not remove, sand, prime or paint placement posts.

- Apply a thin coat of primer to Building Components and Details. Let dry.
- Paint as desired and let dry. See Tips & Techniques on pg. 10 for weathering tips.

TIP! To make priming and painting easier, tape Details (unexposed side down) to loops of masking tape on a piece of cardboard (Fig. 2a and 2b).

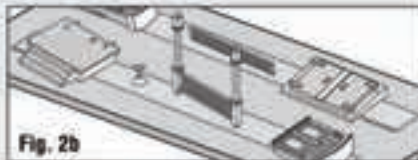

3. Assemble First-Story Walls

- Align Front Wall (1) with Right Wall (2) and snap together (Fig. 3a).
- Align Left Wall (4) with Front Wall (1) and snap together.
- Align Back Wall (3) with Right Wall and Left Wall and snap together (Fig. 3b).

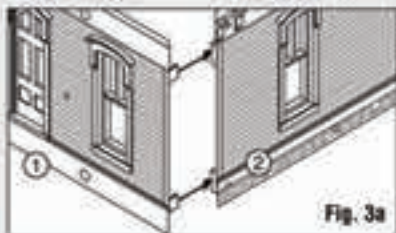

Fig. 3a

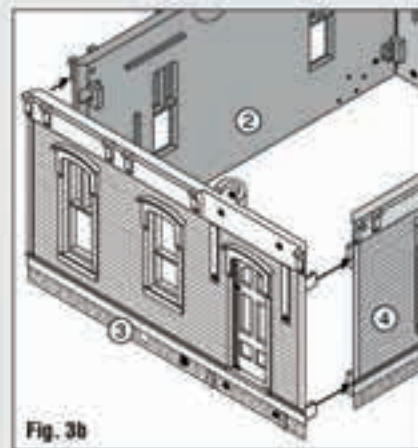

Fig. 3b

4. Install Window Material

Position printed side of Pre-printed Window Material toward inside of Building. Remove the protective film before installation. If clear window treatments are preferred, use Clear Window Material.

- Place First-story Wall Assembly on its front face with the bottom toward you. Align corresponding Window Material against alignment guides over windows on inside of Building. Carefully dab a small amount of glue around edges (Fig. 4a). Repeat for each set of window openings.
- Install Window Material on inside of Dormer Window Inserts ⑧, ⑨ (Fig. 4b). Carefully, dab a tiny amount of glue around edges of Window Material to secure.



5. Install Second-Story and Roof

- Place Frame ⑤ on top of First-story Assembly, aligning notches in Frame with screw tabs on Assembly (Fig. 5a).
- Place Second-story Assembly ⑧ on Frame ⑤, aligning tab on Frame with notch in Second-story Assembly. (Fig. 5a inset)
- From underneath structure, install Phillips Screws 4x (Fig. 5b).
- Align Roof ⑦ with Chimney notches (Fig. 5c) and glue in place.

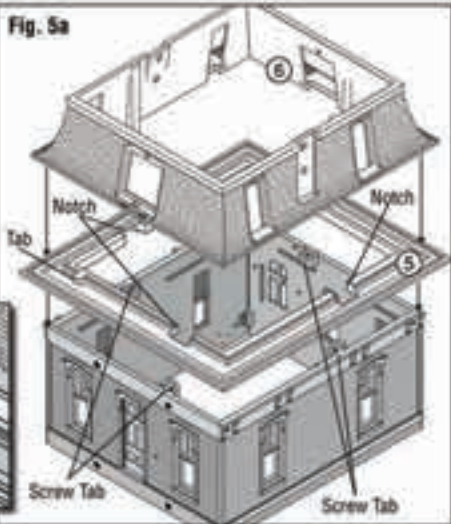

6. Install Dormer Windows and Chimneys

- Glue Large Dormer Windows 2x (8) and small Dormer Windows 4x (9) in place (Fig. 6a).
- Glue Chimneys 2x (10) in place (Fig. 6a).

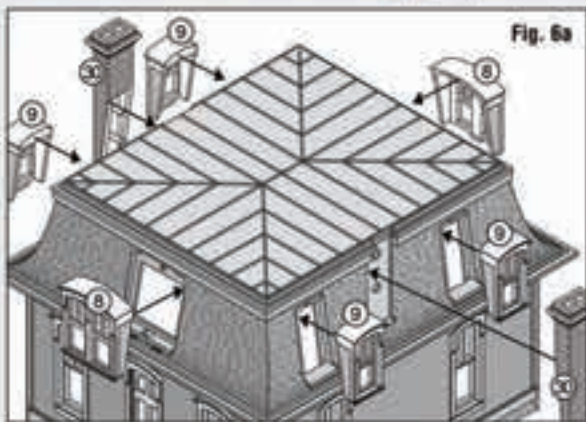

7. Preassemble Details

Assemble and glue the following Detail pieces using CA glue. Use tweezers to make assembly easier.

- Apply a tiny amount of glue onto placement posts on Porch Ceiling (11), then align posts with placement holes in Porch Roof (10) (Fig. 7a).
- Glue Weather Vane Leg (12) to Weather Vane (12) (Fig. 7b).
- Glue Screen to backside of Screen Door (14) (Fig. 7c).
- Glue Individual Flowers 8x (16) in Flowerpot (15). Make two Flowerpots (Fig. 7d).

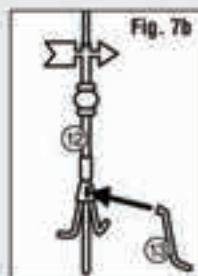
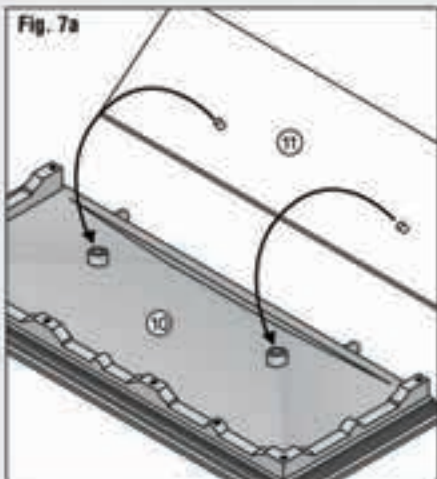

7. Preassemble Details cont.

- Glue Fern Leaves (18, 19) 6x in Hanging Pot (17). Glue ends of Wire to Pot. (Fig. 7e)
- NOTE: There are six extra Fern Leaves. Use extra in Flowerpots, if desired.
- Glue Flowers (21) to Porch Table (20) (Fig. 7f)
- Glue small, curved pieces of Wire to Mailbox (22) (Fig. 7g)
- Glue Back Porch Awning Brackets 2x (25) to Back Porch Awning (26) (Fig. 7h).

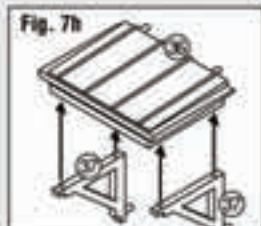
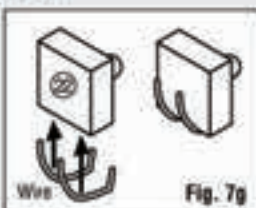
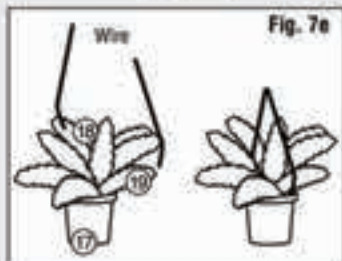

8. Porch and Front of House

Assemble and glue the following Details.

- Glue Mailbox Assembly (22) to Front Wall (Fig. 8a).
- Glue the following items to the Porch (23): Broom (24), Rocking Chairs 2x (25), Flowerpot Assembly (15, 16), Doormat (26), Table with Flowers (20, 21) (Fig. 8b).
- Glue Left-side Porch Railing (27L) to Front Porch Railing (28B) (Fig. 8c). Glue Right-side Porch Railing (27R) to Front Porch Railing (28A). Glue Railing Assemblies (27L, 28A) and (27R, 28B) in place on Porch (Fig. 8d).

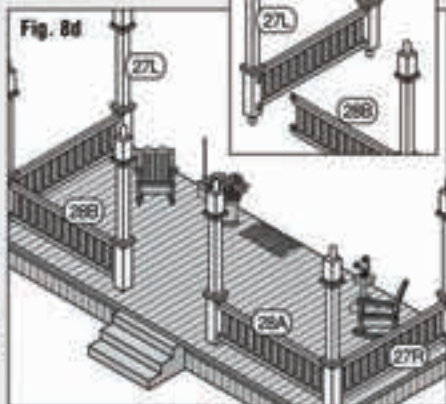
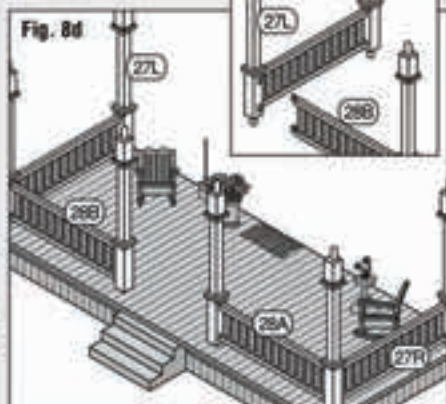
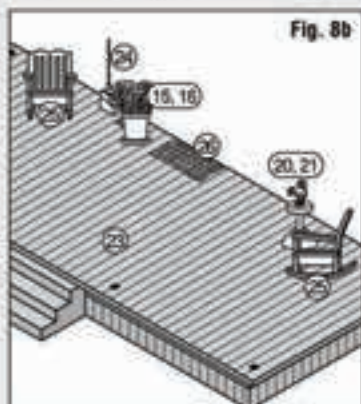
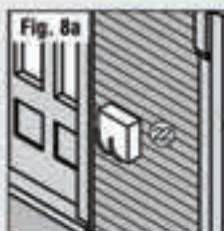

8. Porch and Front of House cont.

- Glue Porch Roof Assembly (10, 11) to top of railing posts. These are easier to assemble with the Porch Roof placed upside down (Fig. 8e).
- Glue Hanging Fern Assembly (18, 19, 20) in place (Fig. 8f).
- Glue Porch Assembly to Front Wall (Fig. 8g).
- Glue Window Boxes 2x (29) in front of second-story window (Fig. 8g).

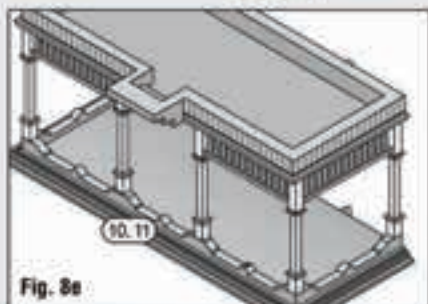

Fig. 8e



Fig. 8f

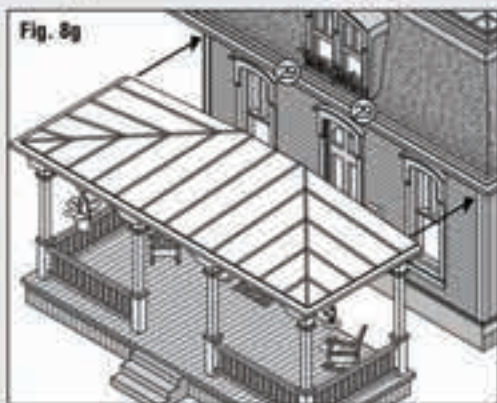

Fig. 8g

9. Install Details

Install Details using CA glue.

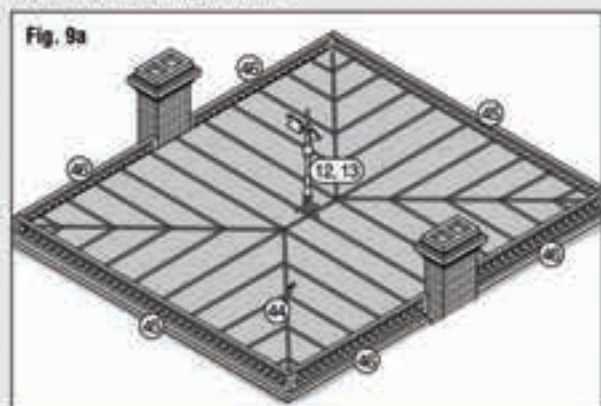
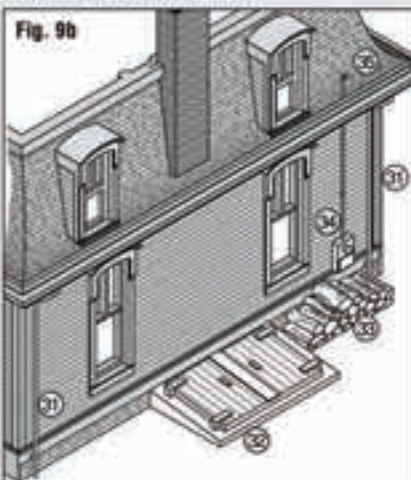

Fig. 9a

Roof (Fig. 9a):
Weather Vane Assembly (12, 13),
Vent (44), Long Roof Railing 2x (45), Short Roof Railing 4x (45)

NOTE: Decorative side of Railing should face out.

9. Install Details cont.



Right Side (Fig. 9b): Downspouts 2x (31), Cellar Door (32), Wood Pile (33), Electrical Box and Mast (34), Top of Electrical Mast (35)

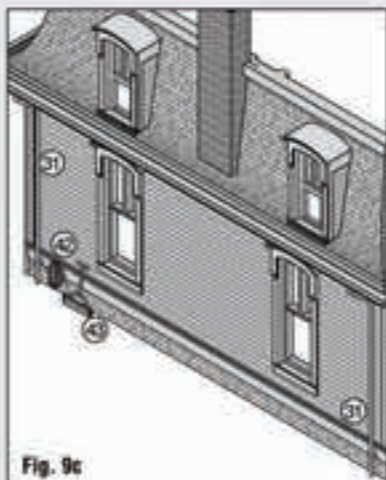

Left Side (Fig. 9c): Downspouts 2x (31), Hose (36), Push Mower (37)

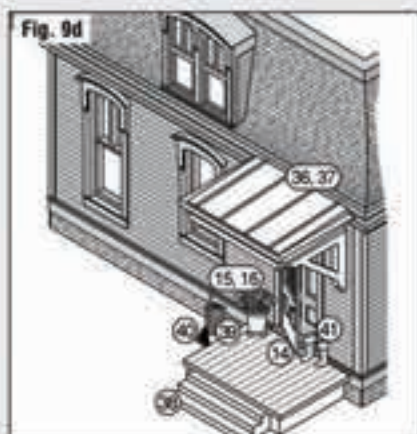

Back (Fig. 9d): Awning Assembly (36, 37), Back Stoop (38), Trashcan (39), Rake (40), Flowerpot Assembly (15, 16), Boots 2x (41), Screen Door (42)

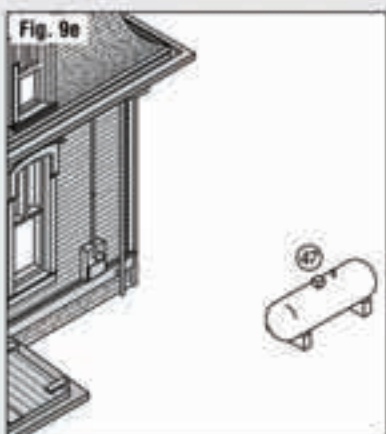

Propane Tank (Fig. 9e): Place Propane Tank (47) anywhere on layout.

10. Blackout Paper

- Cut sheet of Blackout Paper in half widthwise (**Fig. 10a**).
- Lay the two sheets on top of each other. In the center, make a cut half-way up the sheets (**Fig. 10b**).
- Assemble as shown (**Fig. 10c**).
- Insert into building (**Fig. 10d**).
- Place a drop of glue at each corner of the Blackout Paper to hold in place.

Fig. 10a

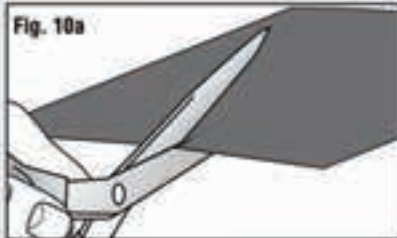

Fig. 10b

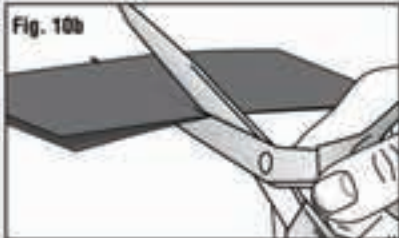

Fig. 10c

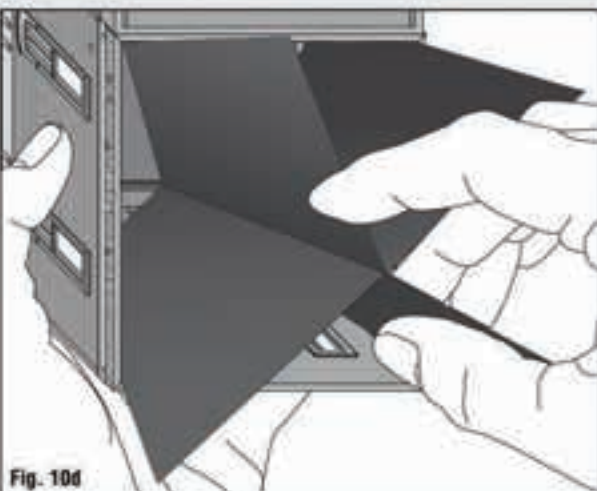
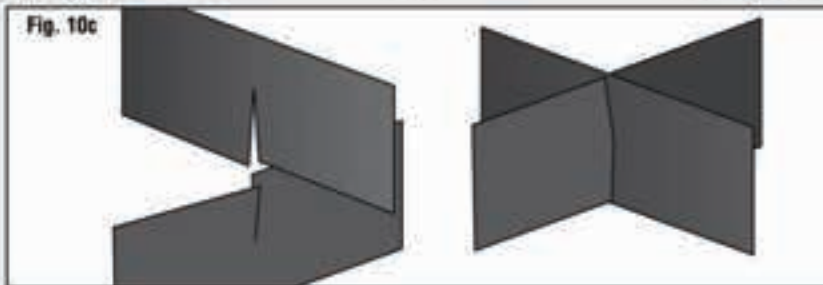

Fig. 10d

TIPS AND TECHNIQUES

Weathering

Weather siding, roof and brickwork.

Weathering Wash: Using a paintbrush, dab on small amounts of wash (formula follows) until desired look is achieved. Sponge off excess.

Formula: Mix together 1-part acrylic paint (color suggestion: Floquil®* Polly Scale™ "Concrete" or "Aged Concrete"), 12-parts rubbing alcohol, 8-parts water and 1 drop liquid dish soap.

Airbrush: Lightly spray thinned flat black paint (color suggestion: Floquil "Grimy Black") to areas where natural discoloration can occur (near windows, chimneys, etc.).

Chalk: Rub a dark color of pastel chalk (color suggestion: gray, black, brown, etc.) on sandpaper to create a chalk dust. Using a paintbrush, dab chalk dust where discoloration can occur.

Visit woodlandscenics.com for How-to Videos and FAQs featuring more great Building Tech Tips.

*Floquil is a Testor Corporation registered trademark.

Design

- Each building is a unique architectural work of art
- Researched and designed by an architect
- Illustrates a superior standard of craftsmanship

Details

- Period-authentic ornamentation
- Realism is captured in crafted details like electrical mass, drainage and fire escape
- Thick styrene plastic construction ensures structure stability

Assembly

- State-of-the-art interlocking wall alignment system for accurate construction
- Finished edges reduce prep time and streamline assembly
- Includes window treatment options

YOU WILL ALSO LIKE

First Bank #12200

First Bank represents an early 1900's Neoclassical-styled Main Street corner building with etched stone fluting and a chiseled roofline parapet. Period details include clear windows, window treatments, corner-hung sign with signature Roman numeral clock, rooftop ductwork, chimneys, downspout, exterior flag pole bracket and Old Glory.



Stone Bakery #12300

Stone Bakery is designed to mirror a late 1800's Victorian storefront complete with stacked Queen Anne bay windows. The exterior brick wall is modeled with hand laid naturally aged and flawed brick and mortar bordered with etched wood fluting. Period details include clear windows, window treatments, storefront vertical sign, fire escapes and porch landings, window air conditioning units, chimneys, downspout and utility fixtures.



Fire Station No 3 #12400

Fire Station No 3 represents the elegant styled firehouses that communities built as a "point of pride," across America. The exquisite architectural details include a wide cornice, curved window caps and an ornate cupola to house the tall tower where fire hoses drained following a fire. Fire Station No 3 includes hinged bay doors and molding that allows easy installation of wiring for interior lighting.



County Courthouse #12500

County Courthouse is a stately representation of American courthouses that stand at the center of every county seat. This two-story, brick-patterned courthouse is highly detailed. Details include chimneys and full roof detail, drainage, propane tank, signage, figures, cannon, flagpole and Old Glory.



Live Wire Manufacturing #12600

Set Live Wire Manufacturing as the centerpiece of your layout's industrial park or alongside a spur. This two-story, highly detailed structure features naturally weathered brick and metal exterior, steel sash vented windows, full roof detail, rooftop water tower, lean-to for spur access with movable overhead wire spooling assembly, signage and more!



We make every effort to ensure our kits are manufactured complete. However, if the kit is missing a part, please make note of the model number and missing part and contact the Woodland Scenics Sales and Customer Service Department, PO Box 98, Lees Creek, MO 65052, 573-340-5555, sales@woodlandscenics.com
X08ST12700 ET ©2012 O CO Printed by a certified Green Printer