

Look for these other HO scale Landmark Structures Building Kits at your local hobby shop.

PF5180 Fresh Market
 PF5181 Planters Feed and Seed Supply
 PF5182 Main Street Mercantile
 PF5185 O'Leary Dairy Distribution
 PF5186 Country Cottage
 PF5187 Woodland Station
 PF5188 D's Diner
 PF5189 Public Pavillion
 PF5190 Rustic Barn
 PF5192 Windmills
 PF5193 Deuce's Bike Shop
 PF5194 Mo Skeeters Bait & Tackle
 PF5195 Buzz's Sawmill
 PF5196 Corner Porch House



Just Plug® LIGHTING SYSTEM

The Just Plug Lighting System is a complete, quick and easy way to add realism to new and existing layouts and other projects. No electrical knowledge or special tools are needed. Just plug and you're done! Individual bulb brightness can be controlled, and special window film eliminates the need for building interiors. The modular design allows for easy expansion, and Just Plug works for all scales.



It's as easy as placing
a light and setting
your building on top.

LANDMARK STRUCTURES®

HO SCALE
1:87
BUILDING KIT

SONNY'S SUPER SERVICE PF5183

Model the bustle of your layout's local full-treatment service station. Each morning, station attendants at Sonny's Super Service fill gas tanks, check oil levels, air tires and offer the latest weather report or newest piece of automotive advice.



MODELING AND CARE INFORMATION

This kit suggests the use of materials that may stain or cause damage. Take care to cover project area and clothing appropriately. Follow recommendations for use and cleanup.

CAUTION: Cutting tools recommended. Use with care.

We make every effort to ensure our kits are manufactured complete. However, if this kit is missing a part, please make note of the kit name, number and missing part. Contact the Sales and Customer Service Department at PO Box 98, Linn Creek, MO 65052, 573-346-5555 or sales@woodlandscenics.com.



WOODLAND SCENICS®

XPF5183INST K5 ©2016 O CO

SONNY'S SUPER SERVICE

Building Kit Contents

- Main Building Shell
- Garage Shell
- Roof
- Sprues with Details
- Clear Window Material
- Dry Transfer Decals
- Blackout Paper
- 4 Phillips Flat Head Screws

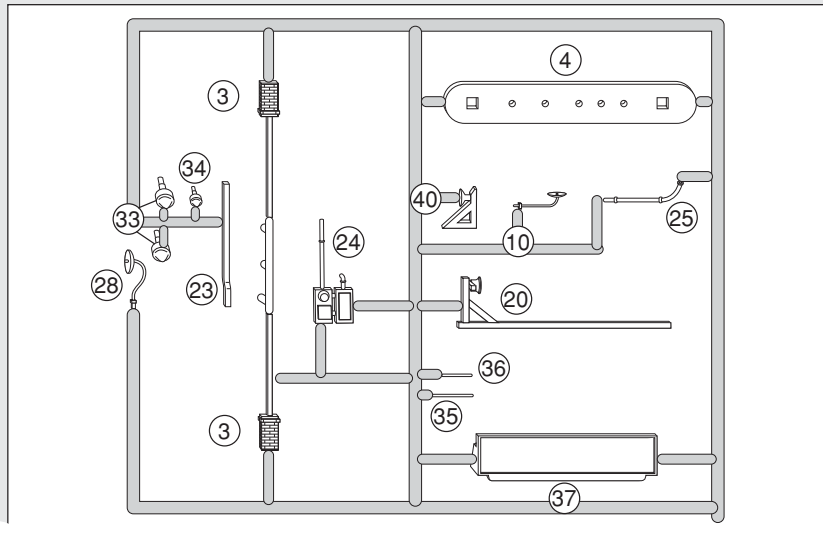
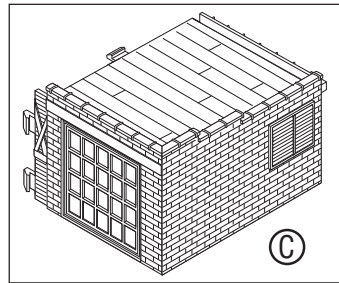
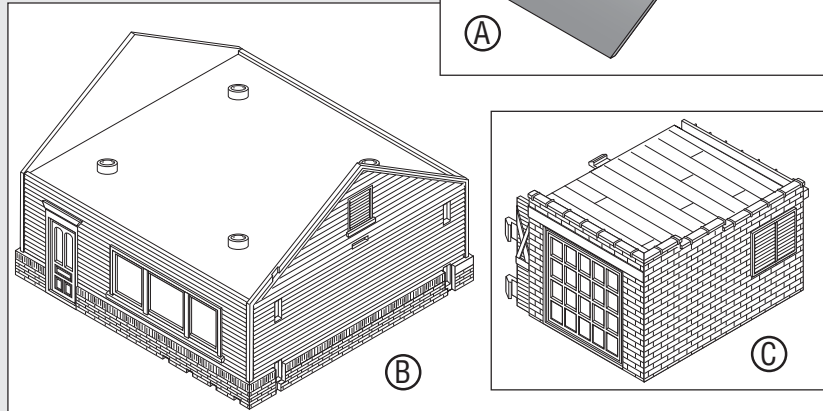
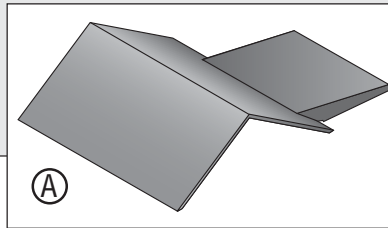

8. Detail Installation cont.

Fig. 8f

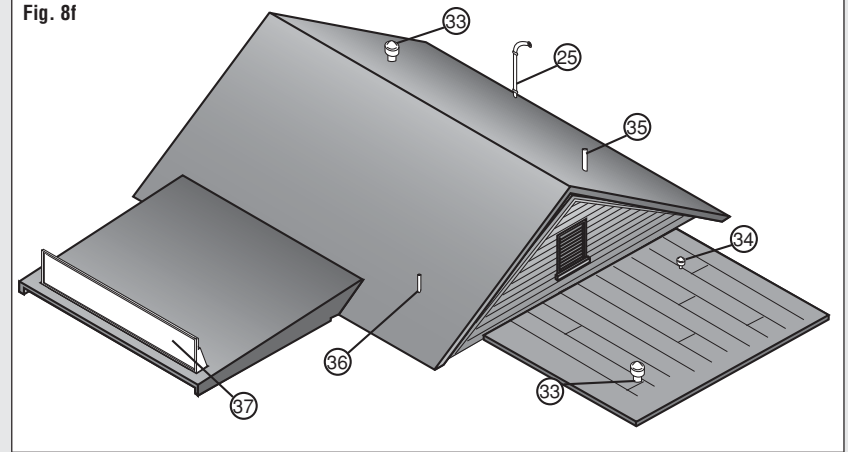

Roof (Fig. 8f): Large Vent 2x (33), Small Vent (34), Tall Tiny Vent (35), Short Tiny Vent (36), Sonny's Super Service Signboard (37), Pipe (25)

9. Blackout Paper

- For the main portion of the **Building**, cut two sheets of **Blackout Paper**, each measuring 4 3/4 in l x 1 3/8 in h.
- For the **Garage**, cut two sheets of **Blackout Paper**, each measuring 3 3/4 in l x 1 3/8 in h.
- Lay the two sheets on top of each other and cut a notch halfway into both sheets (Fig. 9a).
- Assemble as shown and insert into building (Fig. 9b).
- Place a drop of glue at each corner of the **Blackout Paper** to hold in place.

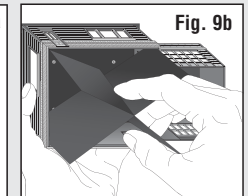
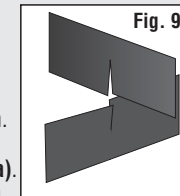

Tips and Techniques

Lighting

To reduce glare and light bleed when lighting structure (lights not included), paint interior walls and underside of roof black or use the Just Plug® Light Block Kit (JP5716).

Concrete Mortar

- To add a realistic mortar appearance, apply a **Concrete Mortar Wash** to brickwork (formula below). Lay building flat so the wash will spread evenly. Avoid Decals and dab on small amounts of Mortar Wash until desired look is achieved. Sponge off excess.
- Concrete Mortar Wash:** 1 part paint (concrete, aged concrete, etc.), 9 parts rubbing alcohol, 7 parts water, 2 drops liquid dish soap

Weathering

- Age decals by scoring and chipping with a hobby knife.
- **Airbrushing Technique:** Lightly spray thinned flat black paint to select areas. Add more where discoloration occurs (near windows, chimneys, etc.).
- **Chalk:** Rub dark pastel chalk (gray, black, brown, etc.) on sandpaper to create chalk dust. Using a paintbrush, dab chalk dust where discoloration can occur.

8. Install Details

Install Details using a cyanoacrylate adhesive (CA glue). Apply a tiny amount of glue to placement post, then align in placement hole. Use tweezers to make installation easier.

NOTE: The following Details do not have placement holes: Mounted Tires 4x (8), Small Tire 2x (13), Canister (14), Small Tire with Block (16), Set of Two Tires (17), Free-Standing Sign (38).

Fig. 8a

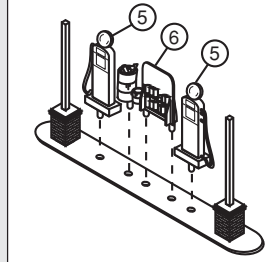

Awning Base (Fig. 8a): Gas Pump 2x (5), Trashcan and Oil Display (6)

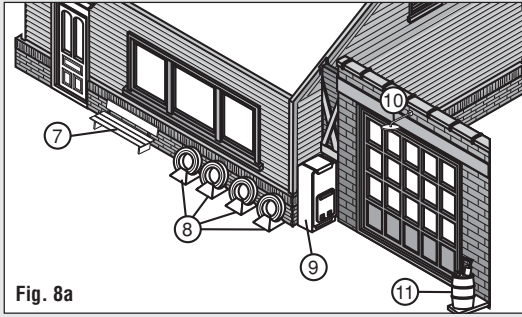
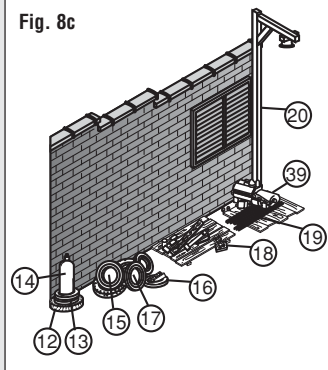

Fig. 8a

Front (Fig. 8b): Bench (7), Mounted Tires 4x (8), Soda Machine (9), Garage Light (10), Barrel (11)

Fig. 8c



Right Side (Fig. 8c): Large Tire (12), Small Tire 2x (13), Canister (14), Large Group of Tires (15), Small Tire with Block (16), Set of Two Tires (17), Pallet with Tools (18), Pallet with Machine and Steel Bars (19), Tall Lamp (20), Car Engine (39)

Left Side (Fig. 8e): Hose (29), Bucket (30), Watering Can (31), Assembled Motorcycle (1,2), Ice Machine (32), Small Lamp (40)

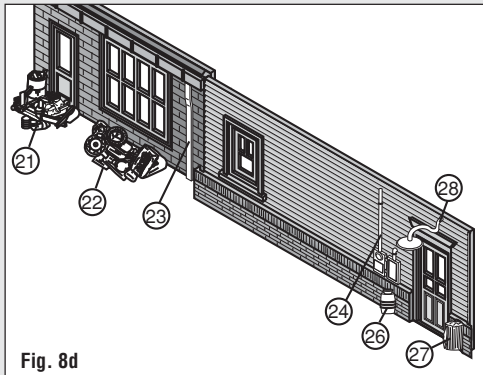

Fig. 8d

Back (Fig. 8d): Trashcan and Trash (21), Pile of Trash with Tires (22), Rain Gutter (23), Electric Meter and Junction Box (24), Barrel (26), Trashcan (27), Light (28)

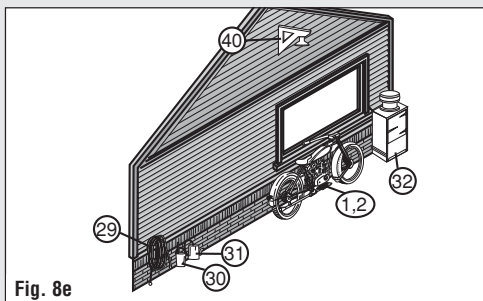
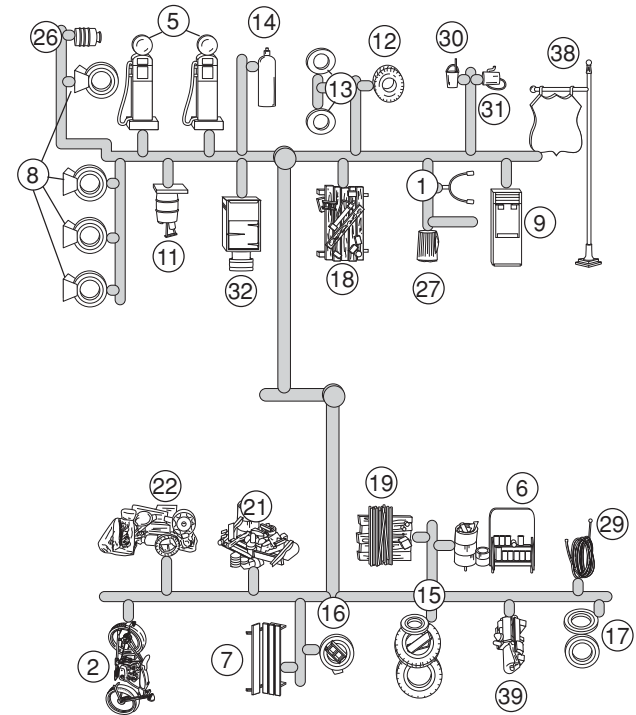

Fig. 8e



Before You Begin

- Read through instructions.
- Collect additional supplies.
- Check kit contents.
- Cover project area with newspaper.

TIP! To assist in assembly, refer to exploded-view illustration on back of box.

Additional Needed Supplies

- Solvent-based Plastic Cement*
- Cyanoacrylate Adhesive (CA glue / super glue)
- Paints (acrylic and/or enamel)*
- Primer*
- Painting Tools
- Hobby Knife / Flush Cutting Shears
- Fine-grade Sandpaper
- Tweezers
- Scissors
- Newspaper
- Ruler
- Burnisher or Dull Pencil
- Small Phillips head Screwdriver

NOTE: Always allow glue to set before moving to the next step. Plastic cement works by dissolving the surface of plastic and welding parts together. Avoid contact with detail on parts.

*Contact your local hobby shop for recommendations.

1. Building and Detail Preparation

- Wash Building Shells, Roof and Details (on sprue) in warm, soapy water using a mild detergent. Rinse and let dry.
- Remove any mold flash from Building Shells using a hobby knife and sandpaper (Fig. 1a).
- Remove Details from sprue using a hobby knife (or flush cutting shears) (Fig. 1b). **NOTE:** Do not remove placement posts.
- Sand off any mold flash and parting lines from Details. **NOTE:** Do not sand placement posts.
- Assemble and glue Handlebars ① to Motorcycle ② (Fig. 1c). Allow to set.

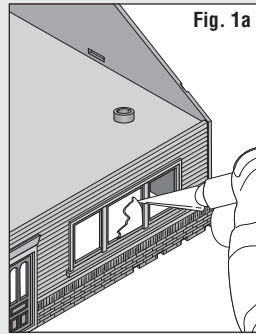

Fig. 1a

Placement Post



Fig. 1b

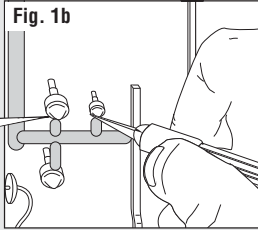
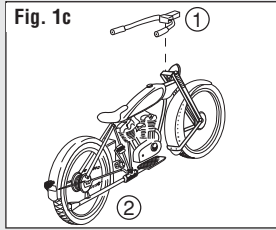

Fig. 1c



2. Roof Installation

- Position Building Shell ② with 3-part window facing front, then place the Roof ① with the canopy facing front (Fig. 2a).
- Install Phillips Flat Head Screws 4x from the bottom (Fig. 2b).

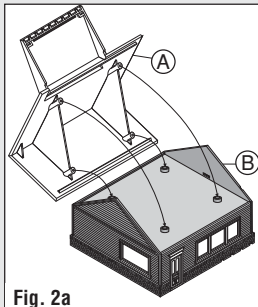

Fig. 2a

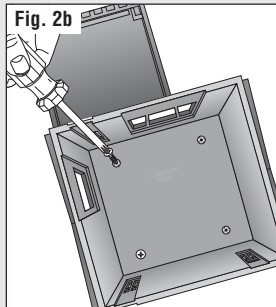

Fig. 2b

3. Garage Installation

- Align tabs on Building Shell ③ with slots on Building Shell ② and snap into place (Fig. 3a).
- Apply glue to inside seams (Fig. 3b).

Fig. 3a

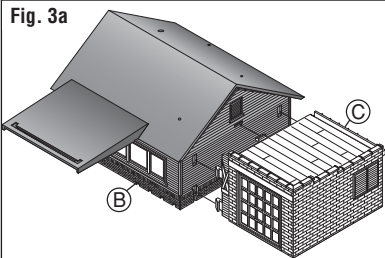
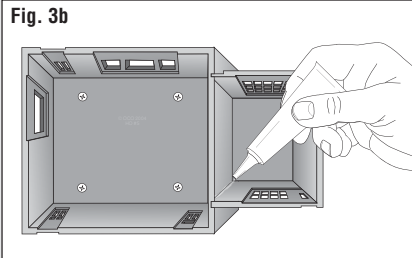

Fig. 3b



4. Front Canopy Support Installation

- Glue the Canopy Support Posts 2x ③ into the placement holes in the canopy (Fig. 4a).
- **NOTE:** Make sure posts are straight.
- Glue the Canopy Support Post Base ④ to the bottom of the Canopy Support Posts ③ (Fig. 4b).

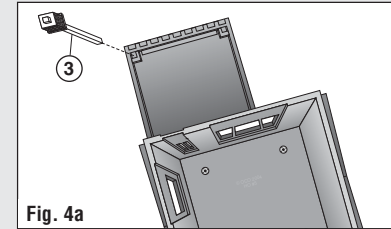

Fig. 4a

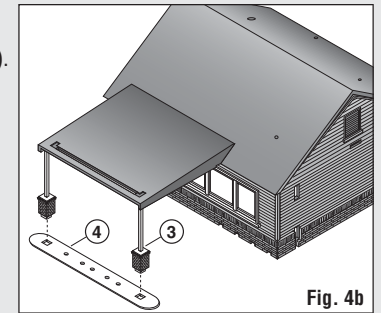

Fig. 4b

5. Prime and Paint

- **NOTE:** Do not prime or paint placement posts.
- Apply a thin coat of primer to Building and Details.
- Allow to dry.
- Paint Building and Details as desired.
- Allow to dry.
- **Optional:** Add a realistic mortar-look (see *Tips and Techniques*, page 6).

Fig. 5a

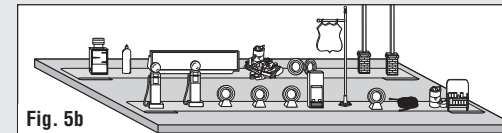
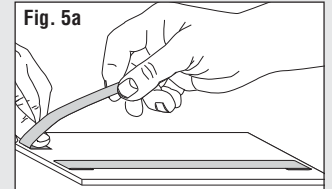

Fig. 5b

TIP! Taping Details (unexposed side down) to loops of masking tape on a piece of cardboard makes priming and painting easier (Fig. 5a and Fig. 5b).

6. Install Window Material

- Remove protective film before installation.
- Cut Clear Window Material to fit over windows on inside of building.
- Place Building on its front face with the bottom toward you (Fig. 6a).
- Center window material over window on inside of building.
- Dab a small amount of glue around edges of window material (Fig. 6a).
- Repeat for each set of window openings.

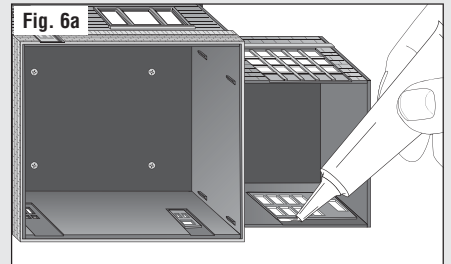

Fig. 6a

7. Decal Application

- **NOTE:** Test-fit signage before applying Dry Transfer Decal. You don't want your sign upside-down!
- Cut out Decals, leaving a slight edge (Fig. 7a).
- Grasp edge of Decal with tweezers. Avoid handling the back.
- Position in desired location and rub over entire Decal area with burnisher or dull pencil (Fig. 7b).
- Carefully lift away carrier sheet.
- Place backing paper over Decal and rub again for maximum adhesion.

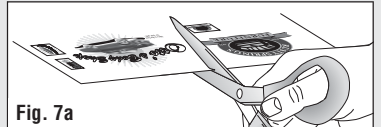

Fig. 7a

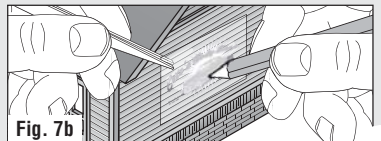

Fig. 7b